

Rethinking Matter

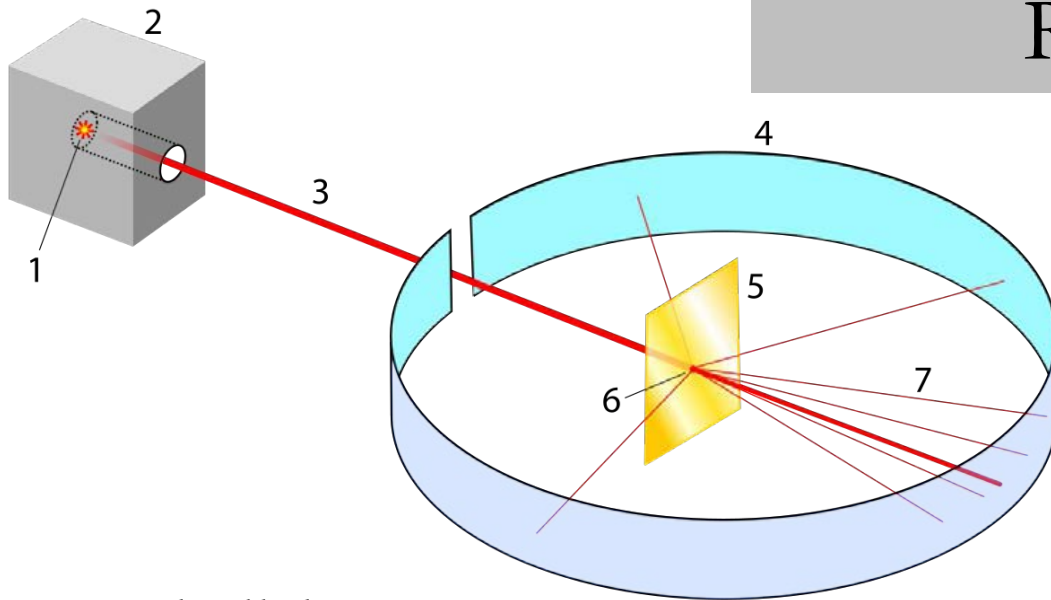

Image is in the public domain.

8.225 / STS.042, Physics in the 20th Century
Professor David Kaiser, 5 October 2020

“Old Quantum Theory” (~ 1900 – 1924*)

Rethinking Light

1. Blackbody radiation (1900)
2. Photoelectric effect (1905)
3. Compton scattering (1922)

Rethinking Matter

1. Rutherford scattering (1911)
2. Bohr atom (1913)
3. de Broglie hypothesis (1924)

today's topic

* dates are approximate! As we will see, physicists debated and revisited each of these topics over a span of years.

Atomic Structure

ОПЫТЪ СИСТЕМЫ ЭЛЕМЕНТОВЪ.
ОСНОВАННОЙ НА ВЪЗЪ АТОМНОМЪ ВѢСѢ И ХИМИЧЕСКОМЪ СХОДСТВѢ.

	Ti = 50	Zr = 90	? = 180.		
	V = 51	Nb = 94	Ta = 182.		
	Cr = 52	Mo = 96	W = 186.		
	Mn = 55	Rh = 104,4	Pt = 197,1		
	Fe = 56	Rn = 104,4	Ir = 198.		
	Ni = Co = 59	Pi = 106,8	O = 109.		
H = 1	Cu = 63,4	Ag = 108	Hg = 200.		
Be = 9,4	Mg = 24	Zn = 65,2	Cd = 112		
B = 11	Al = 27,1	? = 68	Ur = 116	Au = 197?	
C = 12	Si = 28	? = 70	Sn = 118		
N = 14	P = 31	As = 75	Sb = 122	Bi = 210?	
O = 16	S = 32	Se = 79,4	Te = 128?		
F = 19	Cl = 35,5	Br = 80	I = 127		
Li = 7	Na = 23	K = 39	Rb = 85,4	Cs = 133	Tl = 204.
		Ca = 40	Sr = 87,6	Ba = 137	Pb = 207.
		? = 45	Ce = 92		
		?Er = 56	La = 94		
		?Yt = 60	Di = 95		
		?In = 75,5	Th = 118?		

Д. Менделѣевъ

Dmitri Mendeleev's original periodic table of the elements, 1869
Image is in the public domain.

By the 1880s, matter seemed to be well understood: chemical elements consisting of physical atoms.

The mid-1890s, however, brought rapid changes. Aided by new instruments like cloud chambers, fluorescent screens, and photographic techniques, researchers identified several new types of *radiation*.

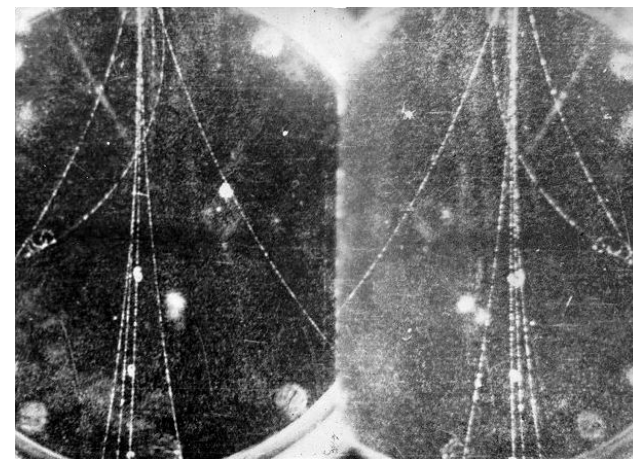

Cloud chamber photographs, early 1900s
© California Institute of Technology. All rights reserved. This content is excluded from our Creative Commons license. For more information, see <https://ocw.mit.edu/help/faq-fair-use/>

Things Fall Apart

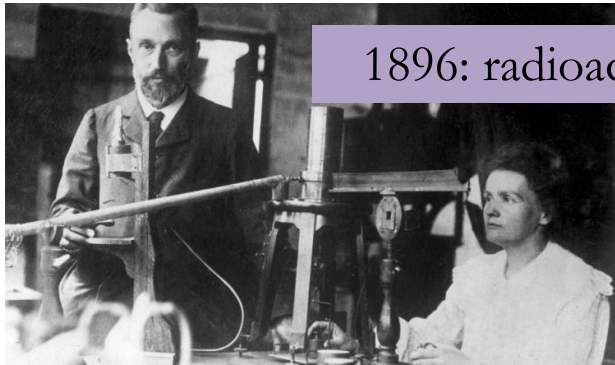

1896: radioactivity

Pierre and Marie Curie in their Paris laboratory, early 1900s

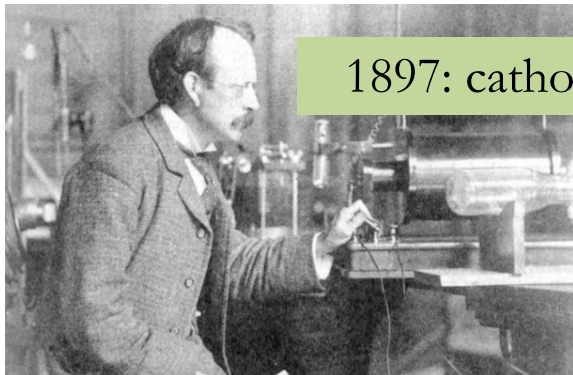

1897: cathode rays

Laboratory (Cambridge University), ca. 1897 images are in the public domain.

The new findings suggested that atoms can fall apart, and that they have internal *structure*. Hence they are not really “atoms”! (The ancient Greek word “atom” means “indivisible.”)

By 1900, researchers had identified at least three distinct types of new radiations. They had different properties — some were easily deflected by magnetic fields, others could ‘fog’ photographic plates — so researchers assigned them different names: α , β , γ , ...

International sensation, then as now...

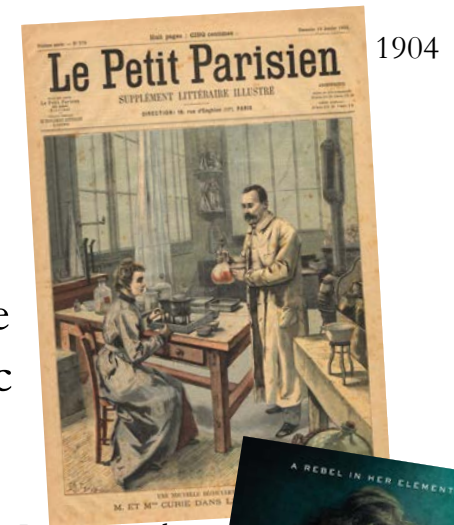

Image is in the public domain.

2019



© Working Title Films/Shoebbox Films. All rights reserved. This content is excluded from our Creative Commons license. For more information, see <https://ocw.mit.edu/help/faq-fair-use/>

Rutherford Scattering

Ernest Rutherford grew up in New Zealand and won a fellowship to study at Cambridge University. He studied under J. J. Thomson at the Cavendish laboratory in the 1890s, just as Thomson was conducting his cathode-ray experiments.

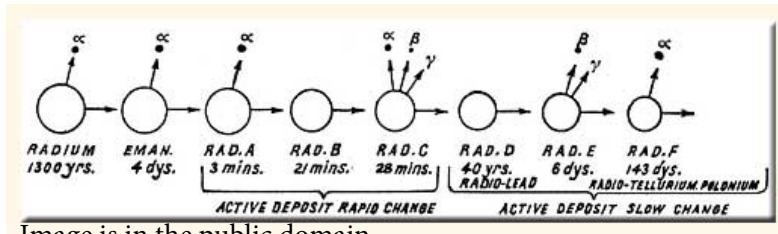
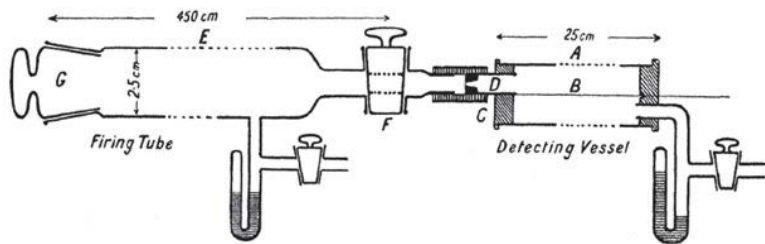

Image is in the public domain.

Rutherford's description of radioactive "transmutation" (1905): a radium atom emits an α particle to become a new substance (now identified as radon); the radon atom emits an α particle to become "Radium A" (now polonium), and so on, with characteristic time-scales for each transition.

Rutherford became fascinated by radioactivity, and identified α rays in the decays of uranium. He also introduced the concept of a "half-life": the time during which the radioactivity of a sample would fall by half.

Rutherford Scattering



Rutherford-Geiger ionization chamber, 1908
Image is in the public domain.

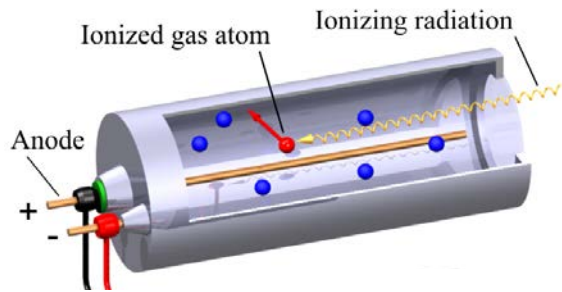

A chamber is filled with an inert gas. When radiation enters, it will ionize atoms within the tube. Given the applied voltage, the ions will flow toward the anode, completing the circuit. Distinct “pulses” or counts can then be identified.

© Svjo-2 on Wikimedia Commons. All rights reserved.
This content is excluded from our Creative Commons
license. For more information, see
<https://ocw.mit.edu/help/faq-fair-use/>

Ernest Rutherford grew up in New Zealand and won a fellowship to study at Cambridge University. He studied under J. J. Thomson at the Cavendish laboratory in the 1890s, just as Thomson was conducting his cathode-ray experiments.

Rutherford became fascinated by radioactivity, and identified α rays in the decays of uranium. He also introduced the concept of a “half-life”: the time during which the radioactivity of a sample would fall by half.

Using a new ionization chamber (developed with *Hans Geiger*, now known as a “Geiger counter”), Rutherford determined in 1908 that α particles carry twice the electric charge (and have the opposite sign) compared to Thomson’s β particles.

Rutherford Scattering

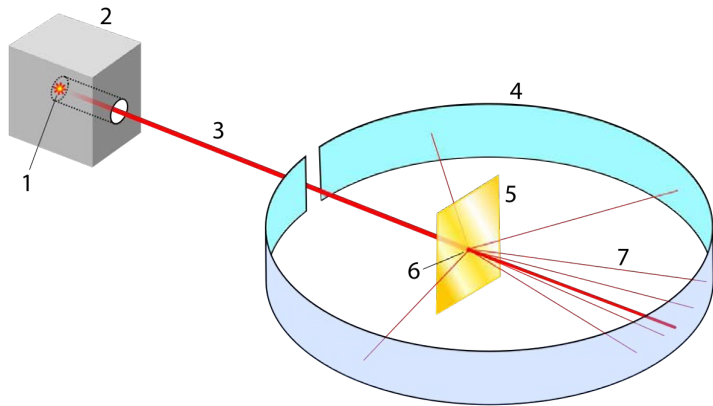

Schematic of 1909-1911 Rutherford-Geiger scattering experiments.

Rutherford and his group at Manchester University (UK) quickly turned α particles into a *tool* to investigate atomic structure. Beginning in 1909, they directed α particles from a radon source toward a thin gold foil. They surrounded the foil with a fluorescent screen, which would flash when struck by an α particle. (Researchers needed to sit in a darkened room and let their eyes adjust, so they could count flashes.)

Most of the time, the α particles passed through with no deflection or only a small deflection θ .

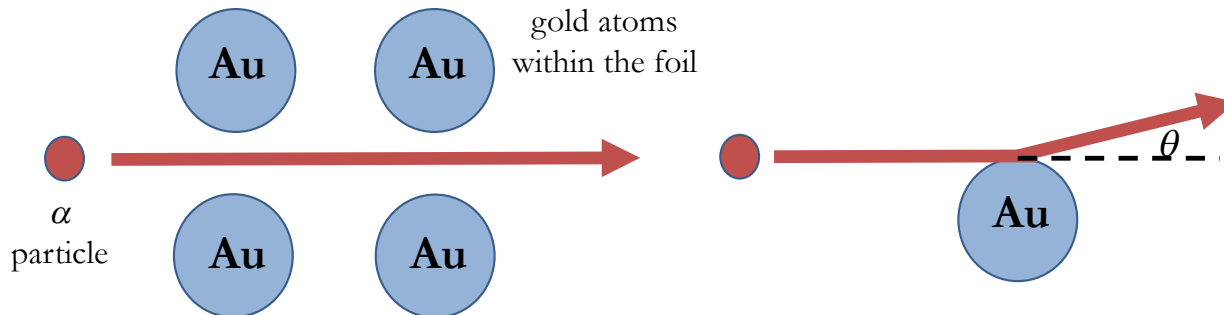

But on rare occasions — about 1 out of every 10^5 events — the α particle would scatter by a *large* angle θ .

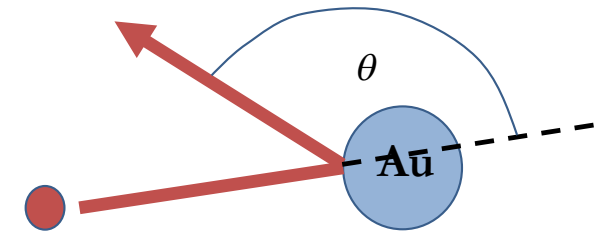

Rutherford Scattering

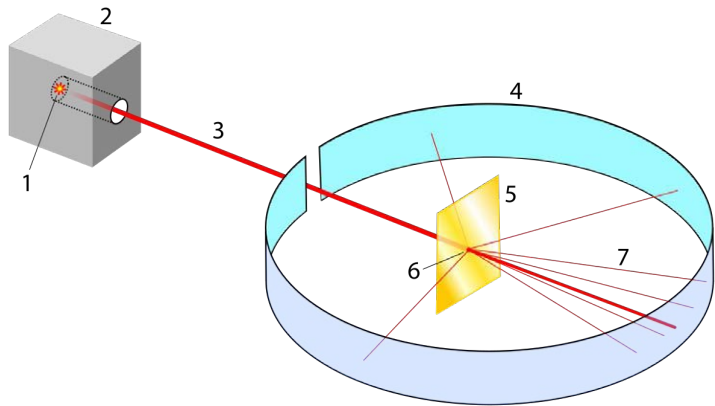

Schematic of 1909-1911 Rutherford-Geiger scattering experiments.

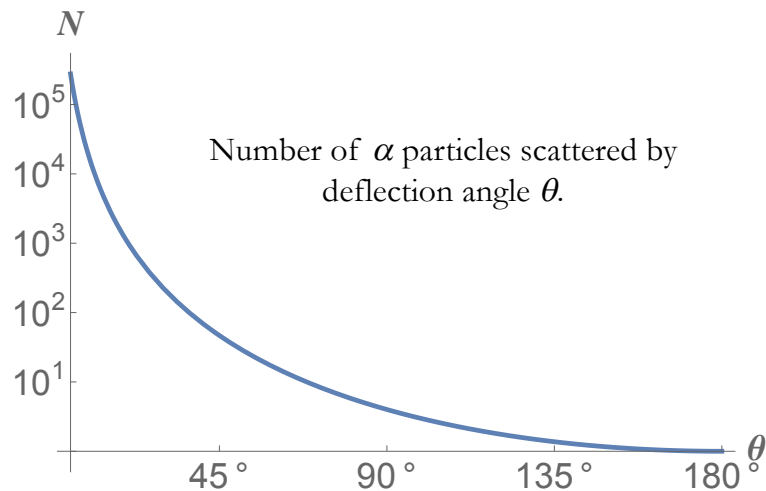

Rutherford and his group at Manchester University (UK) quickly turned α particles into a *tool* to investigate atomic structure. Beginning in 1909, they directed α particles from a radon source toward a thin gold foil. They surrounded the foil with a fluorescent screen, which would flash when struck by an α particle. (Researchers needed to sit in a darkened room and let their eyes adjust, so they could count flashes.)

But on rare occasions — about 1 out of every 10^5 events — the α particle would scatter by a *large* angle θ .

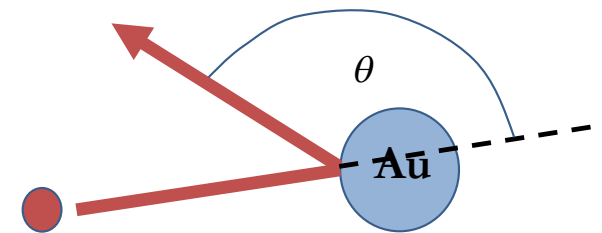

Rutherford Scattering

Rutherford and his group at Manchester University (UK) quickly turned α particles into a *tool* to investigate atomic structure. Beginning in 1909, they directed α particles from a radon source toward a thin gold foil. They surrounded the foil with a fluorescent screen, which would flash when struck by α particles. As the researchers moved their eyes adjust,

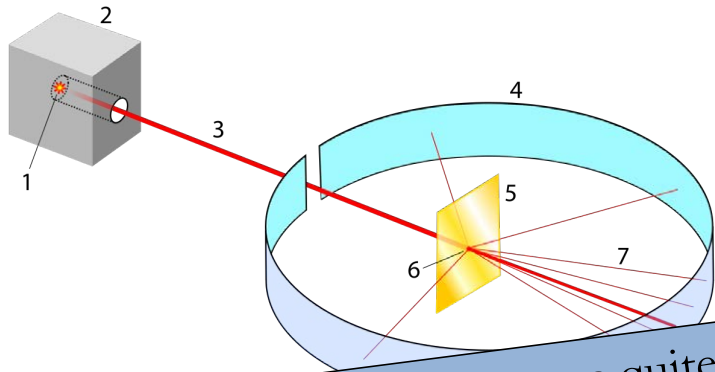

Schematic of 1909

Rutherford: "It was quite the most incredible event that has ever happened to me in my life. It was almost as incredible as if you fired a 15-inch [artillery] shell at a piece of tissue paper and it came back and hit you."

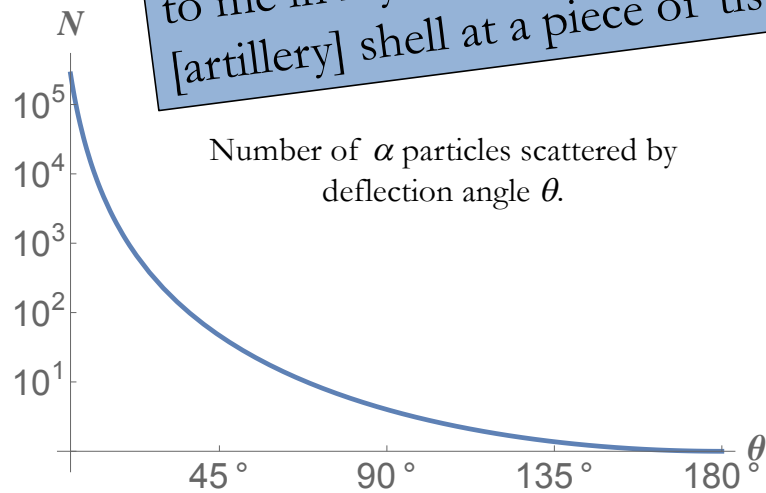

Number of α particles scattered by deflection angle θ .

But on rare occasions — about 1 out of every 10^5 events — the α particle would scatter by a *large* angle θ .

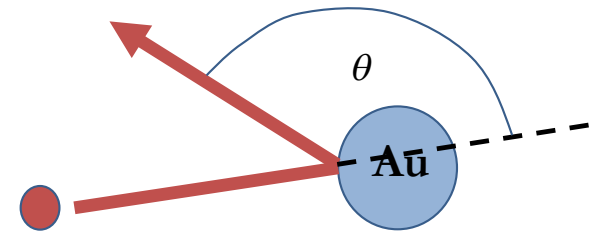

Rutherford Scattering

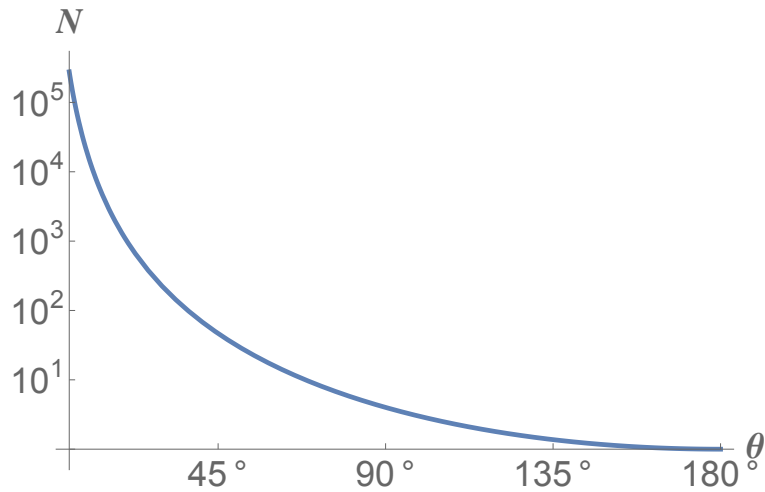

Number of α particles scattered by deflection angle θ .

Rutherford (1911) argued that this scattering pattern only made sense if *most of the atom's mass* were concentrated in a dense “nucleus” in the center: the atom was *mostly empty space*.

The nucleus (like the α particles) must have *positive charge*, while the lightweight “electrons,” with *negative charge* (identified as Thomson's β particles), circled around the nucleus.

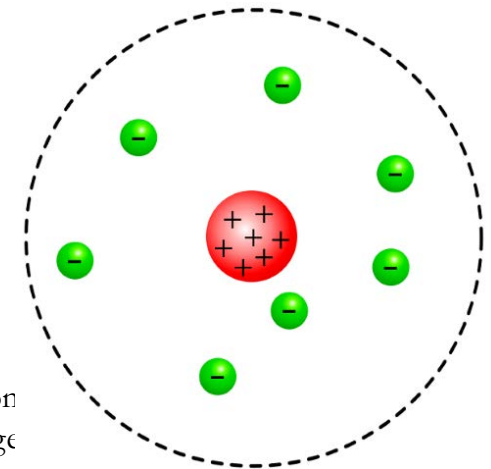

Rutherford model of the atom: massive nucleus in the center with positive charge; lightweight electron surrounding it, with negative charge

Rutherford Scattering

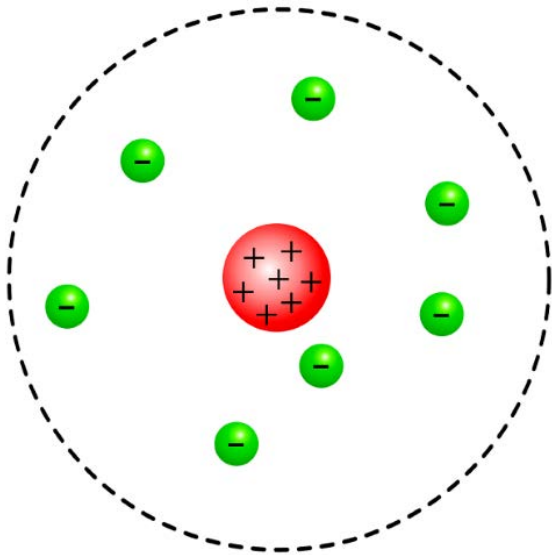

Rutherford model of the atom: massive nucleus in the center with positive charge; lightweight electrons surrounding it, with negative charge.

By 1911, Rutherford had introduced a ‘solar system’ model of atomic structure. But this led to new questions:

Electrons would be constantly *accelerated* as they moved around the nucleus. According to Maxwell’s electromagnetic work, accelerated charges should *radiate*. *Where is all that light?*

Even more important: the electrons should *lose energy* as they radiated. So why didn’t electrons quickly crash into the nucleus? *Why is matter stable at all?*

Questions?

Bohr Model

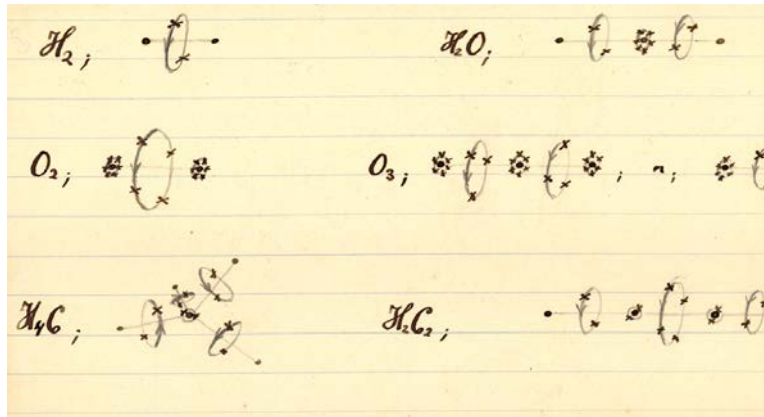

Bohr's notes (1913) on atomic and molecular structure

Niels Bohr was a young Danish physicist, who was a postdoc in Rutherford's group between 1911-1913. He was fascinated by the new Rutherford model of atomic structure, but also puzzled by the question of the stability of matter.

Bohr aimed to account for atomic structure from first principles, with a goal of accounting for all the elements of the periodic table.

He began by considering electrostatic repulsion and magnetic effects among electrons in *multi-electron atoms and molecules*, seeking equilibrium configurations. Perhaps such balanced configurations could account for why matter was stable.

Bohr Model

$$F_{\text{electromagnetic}} = -\frac{e^2}{r^2},$$
$$F_{\text{centrifugal}} = \frac{mv^2}{r}$$
$$\sum_i F_i = 0 \implies v^2 = \frac{e^2}{mr}$$

When that proved cumbersome, he turned to the simplest case of a hydrogen atom, with a single electron. Again for simplicity, he considered a circular orbit. By balancing the forces, he could solve for the electron's velocity. In these expressions, both v and r were *continuous* variables.

Next he *imposed* a new “quantum condition,” that the electron's orbital angular momentum could only take specific values. He was inspired by Planck and (especially) Einstein, who had emphasized *discreteness* at a scale set by Planck's constant h .

$$J = mvr = n\hbar$$
$$n = 1, 2, 3, \dots, \quad \hbar \equiv \frac{h}{2\pi}$$

Now Bohr had two expressions for v ; equating them, he could solve for r . The allowable radii for electron orbits were now *discrete*:

$$r = \frac{n^2 \hbar^2}{me^2} = n^2 a_0$$

“Bohr radius”: $a_0 \equiv \frac{\hbar^2}{me^2} = 5.3 \times 10^{-11} \text{ m}$

Bohr Model

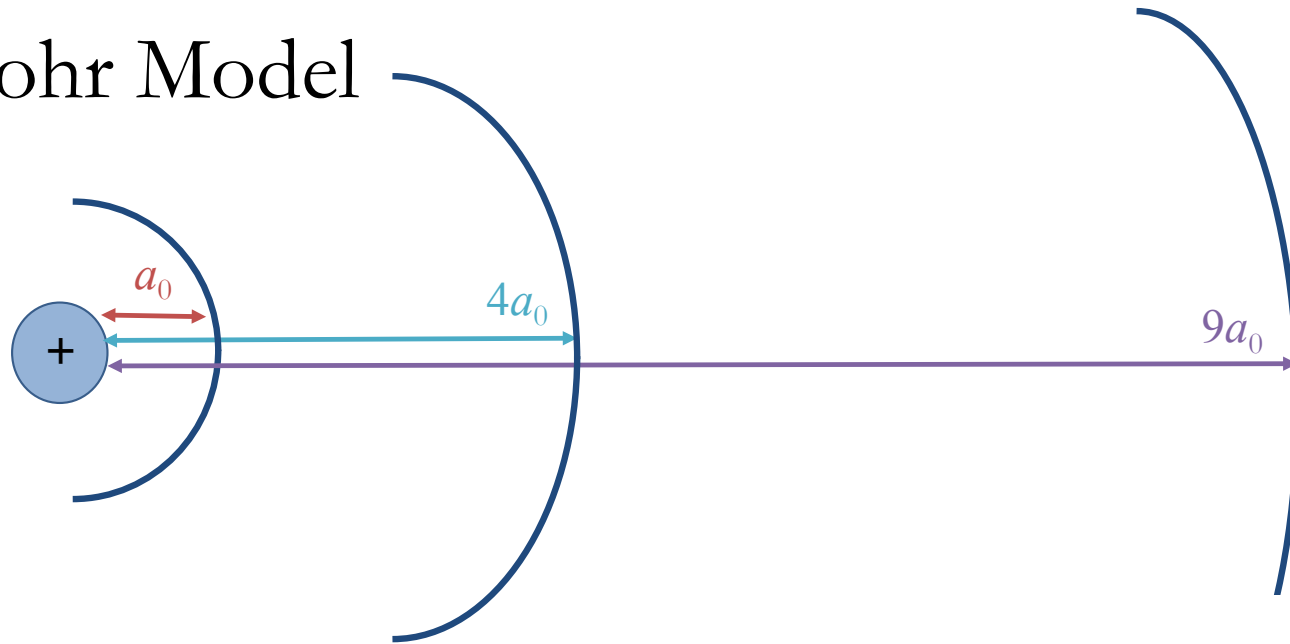

$$r = \frac{n^2 \hbar^2}{m e^2} = n^2 a_0$$

Discrete orbits

$$E = \frac{1}{2} m v^2 - \frac{e^2}{r}$$

$$\left(\text{substitute } v^2 = \frac{e^2}{m r} \right) : E = -\frac{1}{2} \frac{e^2}{r}$$

$$\left(\text{substitute } r = n^2 a_0 \right) : E = -\frac{1}{2} \frac{e^2}{n^2 a_0}$$

$$\left(\text{use definition of } a_0 \right) : E = -\frac{1}{2} \frac{m e^4}{\hbar^2} \frac{1}{n^2}$$

Bohr Model

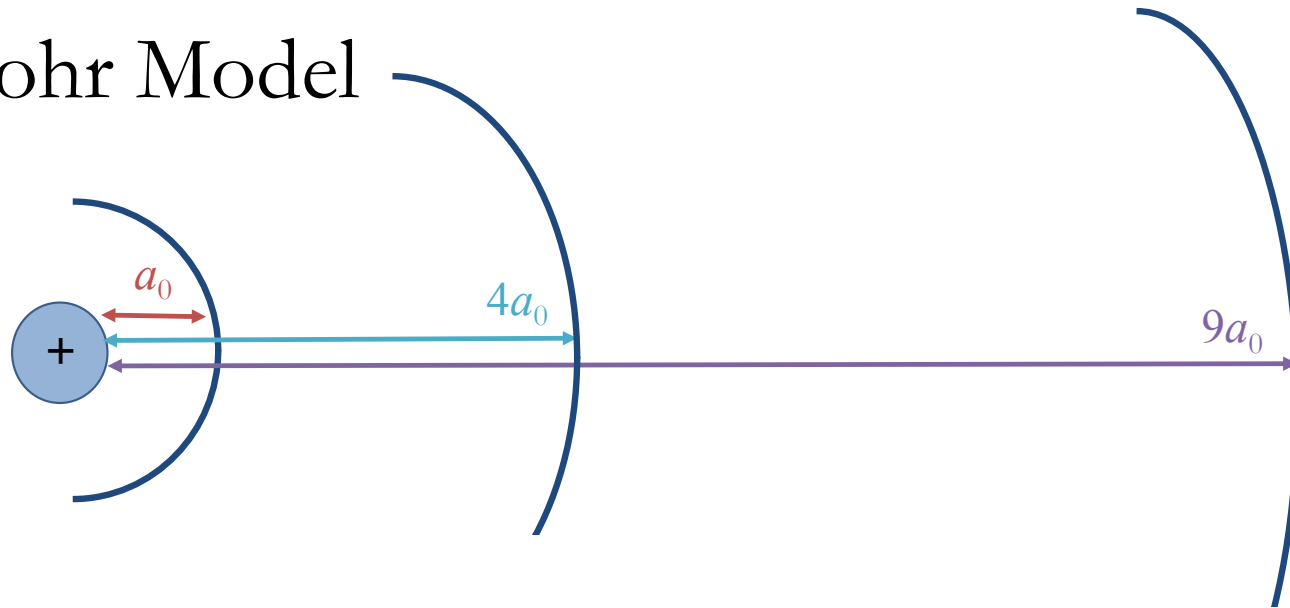

$$E = -\frac{1}{2} \frac{me^4}{\hbar^2} \frac{1}{n^2}$$

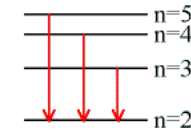
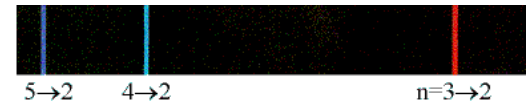

$$\Delta E = E_2 - E_1 = \frac{1}{2} \frac{me^4}{\hbar^2} \left[\frac{1}{n_1^2} - \frac{1}{n_2^2} \right] \quad (\text{for } n_2 > n_1)$$

————— n=1 (Ground State)
 R: “Rydberg constant”

Now Bohr got excited! *Balmer spectrum* from excited hydrogen atoms:

$$\nu = R \left[\frac{1}{n_1^2} - \frac{1}{n_2^2} \right] \quad \text{Johann Balmer, 1885}$$

Bohr proposed: light would be *emitted* whenever an electron jumped from an “excited” orbit to a lower-energy orbit: $\Delta E = h\nu$, or:

$$\nu = \frac{me^4}{4\pi\hbar^3} \left[\frac{1}{n_1^2} - \frac{1}{n_2^2} \right]$$

Bohr Model

Bohr was reluctant to publish his new ideas, because he had only treated hydrogen atoms; his goal had been to account for the stability and structure of *all* the atoms of the periodic table! Happily, Rutherford convinced Bohr to publish anyway (1913).

Central to Bohr's explanation was the new "quantum condition" ($J = n\hbar$), which restricted electrons to *discrete* orbits ($r = n^2a_0$); only for those choices of r would the atom remain stable. Bohr had neither derived nor explained the origin of his proposed "quantum condition," but by using it he had been able to reproduce the Balmer spectrum for hydrogen.

The question still remained: why didn't this discreteness appear in ordinary experience? Bohr worked out the "*correspondence principle*": in the limit of large quantum numbers, $n \gg 1$, quantum systems should reproduce classical behavior.

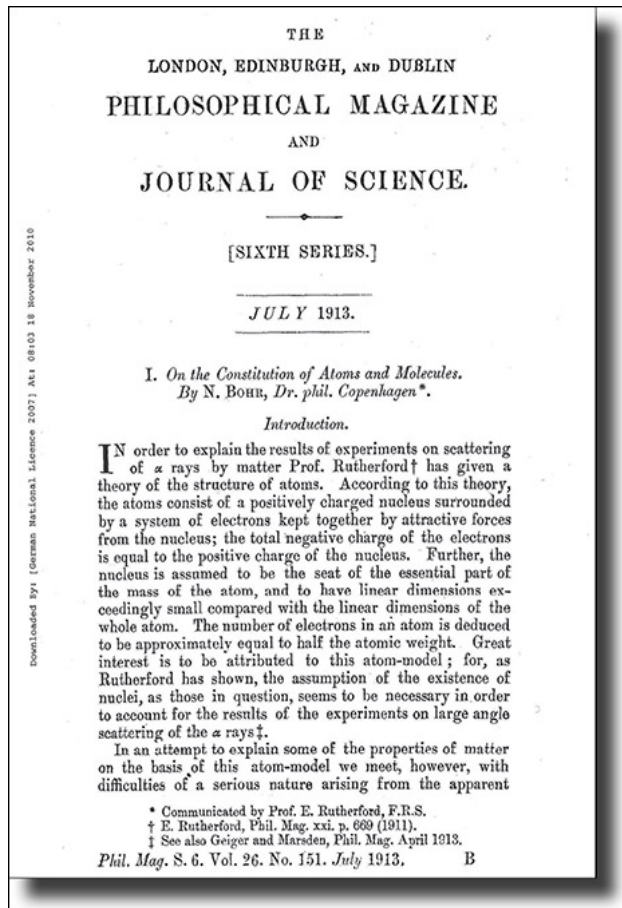

Bohr's Correspondence Principle

According to Maxwell's electrodynamics, $\nu_{\text{radiation}}$ should be *equal* to $\nu_{\text{mechanical}}$, the frequency of the mechanical motion of the moving charge:

$$\nu_{\text{mechanical}} = \frac{1}{T} = \frac{v}{2\pi r}$$

$$\left(\text{use } v^2 = \frac{e^2}{mr} \right) : \nu_{\text{mechanical}} = \frac{1}{2\pi} \frac{e}{\sqrt{m} r^{3/2}}$$

According to Bohr's atomic model, $\nu_{\text{radiation}}$ is given by the *energy difference* between *discrete electron orbits*:

$$\nu_{\text{radiation}} = \frac{me^4}{4\pi\hbar^3} \left[\frac{1}{n_1^2} - \frac{1}{n_2^2} \right]$$

$$\left(\text{use definition of } a_0 \right) : \nu_{\text{radiation}} = \frac{e^2}{2ha_0} \left[\frac{1}{n_1^2} - \frac{1}{n_2^2} \right]$$

$$\left(\text{consider } n_2 = n_1 + \Delta n, \Delta n \ll n_1 \right) : \nu_{\text{radiation}} = \frac{e^2}{ha_0} \frac{\Delta n}{n_1^3} \left(1 + \mathcal{O}[(\Delta n/n_1)^2] \right)$$

$$\frac{\nu_{\text{radiation}}}{\nu_{\text{mechanical}}} = \left(\frac{e^2}{ha_0} \frac{\Delta n}{n_1^3} \right) \left(\frac{2\pi\sqrt{m} r^{3/2}}{e} \right)$$

$$\left(\text{use } r = n_1^2 a_0 = \frac{n_1^2 \hbar^2}{me^2} \right)$$

$$\frac{\nu_{\text{radiation}}}{\nu_{\text{mechanical}}} = \Delta n \rightarrow 1$$

for transitions between neighboring states n_1 and $n_2 = n_1 + 1$, for $n_1 \gg 1$.

Bohr's Correspondence Principle

According to Maxwell's electrodynamics, $\nu_{\text{radiation}}$ should be *equal* to $\nu_{\text{mechanical}}$, the frequency of the mechanical motion of the moving charge:

$$\nu_{\text{mechanical}} = \frac{1}{T} = \frac{v}{2\pi r}$$

$$\left(\text{use } v^2 = \frac{e^2}{mr} \right) : \nu_{\text{mechanical}} = \frac{1}{2\pi} \frac{e}{\sqrt{m} r^{3/2}}$$

According to Bohr's atomic model, $\nu_{\text{radiation}}$ is given by the *energy difference* between *discrete electron orbits*:

$$\frac{\nu_{\text{radiation}}}{\nu_{\text{mechanical}}} = \left(\frac{e^2}{ha_0} \frac{\Delta n}{n_1^3} \right) \left(\frac{2\pi\sqrt{m} r^{3/2}}{e} \right)$$

For large quantum numbers ($n \gg 1$), quantum systems *do* behave like classical ones.

$$\left(\text{use definition of } a_0 \right) : \nu_{\text{radiation}} = \frac{4\pi\hbar^3}{2ha_0} \left[\frac{1}{n_1^2} - \frac{1}{n_2^2} \right]$$

$$\left(\text{consider } n_2 = n_1 + \Delta n, \Delta n \ll n_1 \right) : \nu_{\text{radiation}} = \frac{e^2}{ha_0} \frac{\Delta n}{n_1^3} \left(1 + \mathcal{O}[(\Delta n/n_1)^2] \right)$$

$$\frac{\nu_{\text{radiation}}}{\nu_{\text{mechanical}}} = \Delta n \rightarrow 1$$

for transitions between neighboring states n_1 and $n_2 = n_1 + 1$, for $n_1 \gg 1$.

Bohr Model

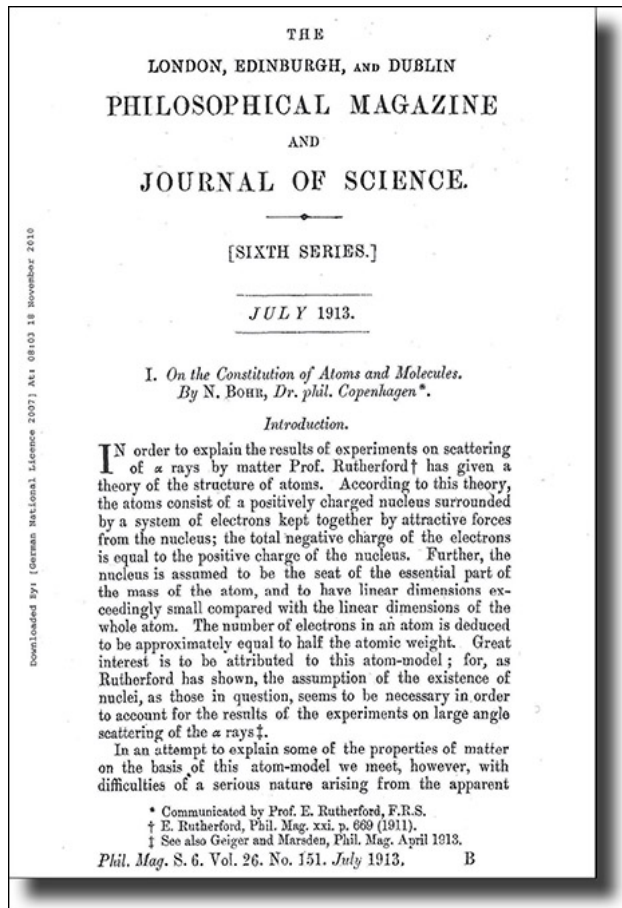

The Bohr model further developed Rutherford's model of atomic structure, and successfully accounted for the Balmer spectrum of hydrogen. But several questions remained:

- It only seemed to work for single-electron atoms (H, He⁺, Li⁺⁺).
- *Why* quantize angular momentum, $J = n\hbar$?
- What happened to electrons *between* stable orbits?
- What determined *when* an electron would “jump” between orbits?
 - How did an electron “know” what energy $h\nu$ to radiate as light, before landing at a different stable orbit?
 - How to account for the relative *intensities* of spectral lines?

Questions?

de Broglie's Hypothesis

In his 1924 Ph.D. dissertation, a French aristocrat, *Louis de Broglie*, offered a hypothesis to account for Bohr's strange quantum condition, $J = n\hbar$. He began with Einstein's work on photons (which had recently been set on a more solid footing, given Arthur Compton's X-ray scattering results):

$$p = \frac{E}{c} = \frac{h\nu}{c}$$

$$\rightarrow p = \frac{h}{\lambda}$$

Then de Broglie simply *asserted* that the same relation should hold for *matter*.

$$p = mv = \frac{h}{\lambda}$$

$$\rightarrow \lambda = \frac{h}{mv}$$

For a thrown baseball, $\lambda_{\text{baseball}} \sim 10^{-32}$ m, totally unobservable on human scales. But $\lambda_{\text{electron}} \sim 10^{-11}$ m $\sim a_0$: for an electron, the “waviness” was *on the same scale* as the electron's own orbit.

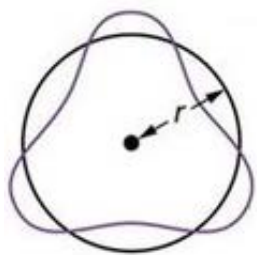

constructive interference

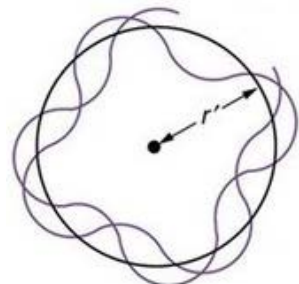

destructive interference

What if stable electron orbits arose from *constructive interference* of the corresponding waves?

$$2\pi r = n\lambda$$

$$2\pi r = n \left(\frac{h}{mv} \right)$$

$$\Rightarrow J = mvr = n\hbar$$

de Broglie Waves

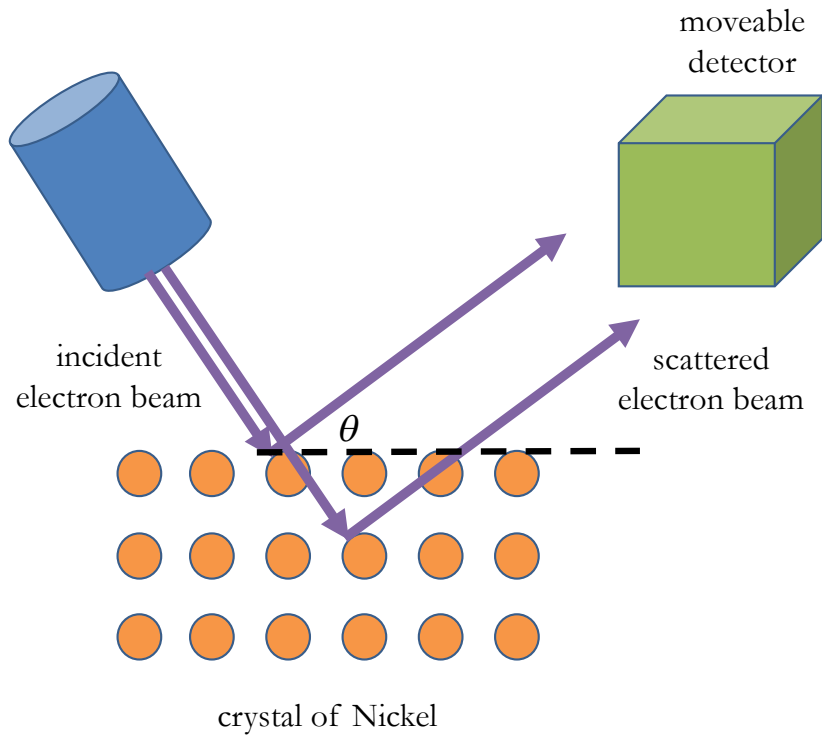

In 1927, *Clinton Davisson* and *Lester Germer*, at Bell Labs, found electron scattering results consistent with the concept of de Broglie waves: the scattered intensity showed a distinctive *interference pattern*.

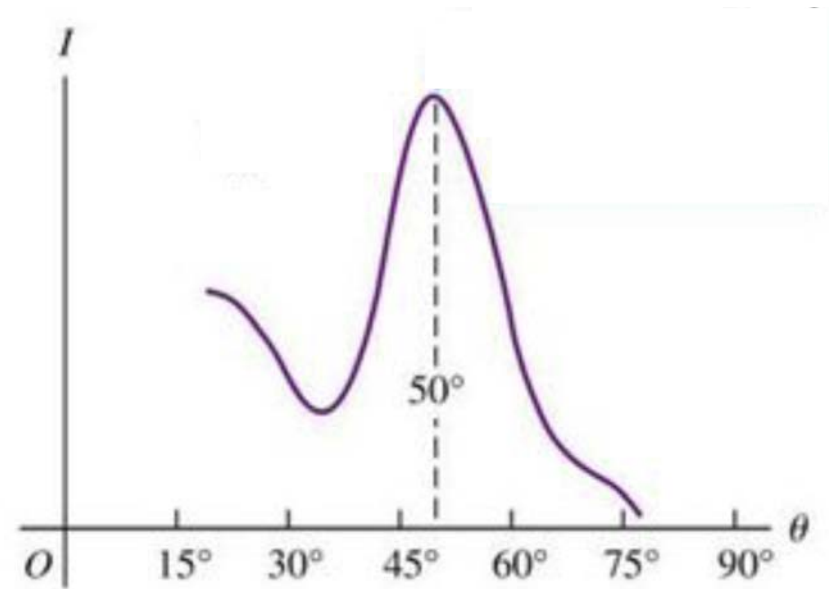

“Old Quantum Theory”

Between 1900 – 1924, physicists dramatically reassessed their assumptions about *light* and *matter*. In contrast with the great triumph of 19th century physics — the wave theory of light — several physicists began to explore *discrete* or *particle-like* attributes of light (blackbody radiation, Einstein’s light-quantum hypothesis, and Compton scattering). Meanwhile, de Broglie could only salvage Bohr’s new “quantum condition,” $J = n\hbar$, by suggesting that matter had *wave-like* properties.

By the early 1920s, each of the successes of the emerging quantum theory seemed to follow a pattern: begin with *classical* expressions for force or energy, and then append some new, unexplained “quantum condition” ($E = h\nu$ or $J = n\hbar$ or $\lambda = h/p$). Though many of these models could account for (otherwise puzzling) experimental results, it was not clear whether each new model for a given phenomenon was consistent with other (equally ad hoc) models.

Quantum theory seemed to many physicists to have become a disorganized grab-bag of heuristic guesses and disjointed models, united only by their invocation of Planck’s constant h and some sort of conceptual break with 19th century physics.

MITOpenCourseWare
<https://ocw.mit.edu>

STS.042J / 8.225J Einstein, Oppenheimer, Feynman: Physics in the 20th Century
Fall 2020

For information about citing these materials or our Terms of Use, visit: <https://ocw.mit.edu/terms>.